

T - 482101 - UFC-3 UNIVERSAL FLANGE CLAMP

General description

The UFC universal flange clamp is designed to tight up the flanges of two duct sections.

It will ensure a better compression of the sealing gasket between flanges and will rigidify the assembly.

Our UFC-3 clamp is suitable for all types of flanges.



Technical description

- Galvanized steel (coating $3 \pm 5 \mu\text{m}$)
- Standard thickness 3,0 mm
- Hexagonal head screw M8
- Delivered in boxes of 100 PCS

Dimensions

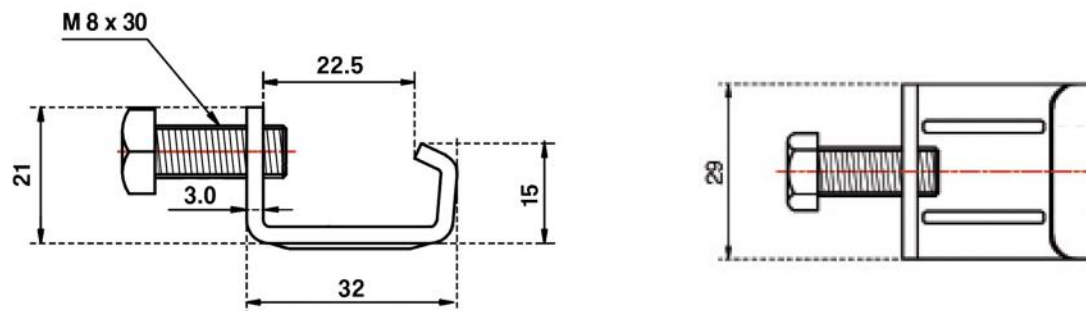

Application

We recommend to fasten one clamp every 20 cm and at least one clamp on each side.

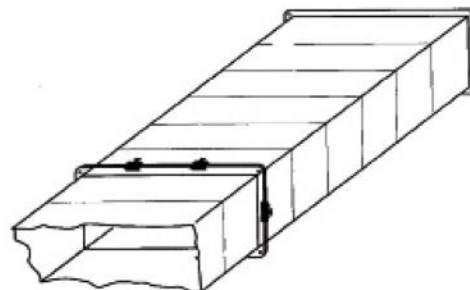
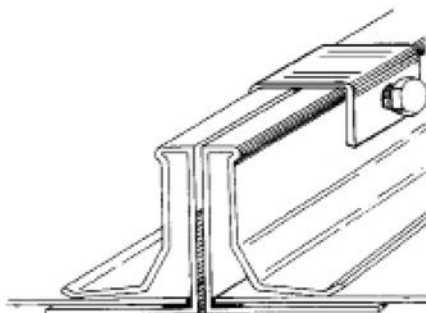

Information contained herein is based on careful tests and experience. It reflects our knowledge and is for guidance purpose only. It is given in good faith and user should ensure that the product is fit for purpose before any application. The quoted values are average and should not be taken as maximum or minimum values for specific purposes. Manufacturer and distributor are not responsible for any non-recommended use or consequential damage.



NEU 6000, S.A.

Pol. Ind. "La Torre"
Av. Joaquim de Barnola i Bassols, 6
08760 Martorell - Barcelona
SPAIN

T. +34 93 774 57 09
F. +34 93 774 18 33
neu@rami-system.es
www.rami-system.es